

Electric system

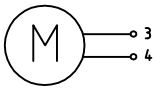

Quick stop push-button

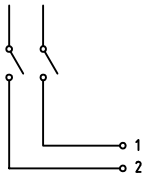
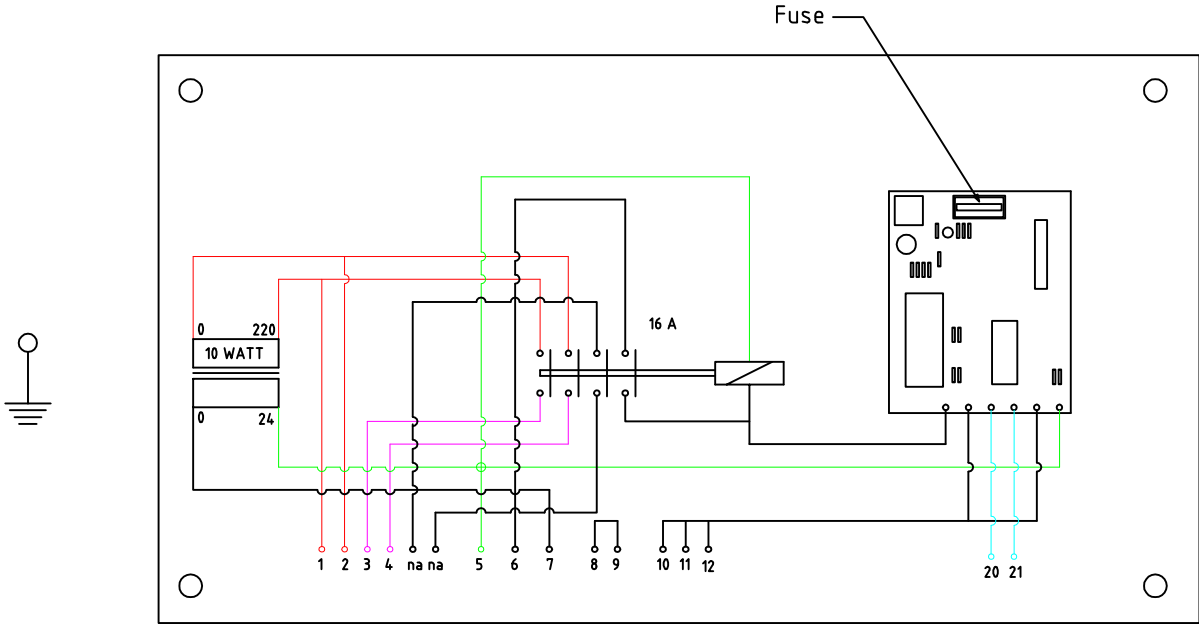
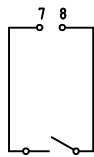
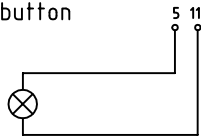

Sensor of the plastic safety guard

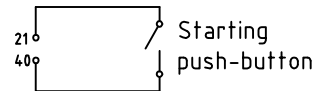

Starting push-button

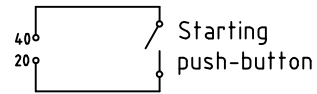

Starting push-button

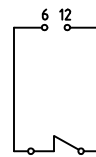

End-of-stroke sensor